

# Digital Telemetry Solutions

integrated • flexible • reliable

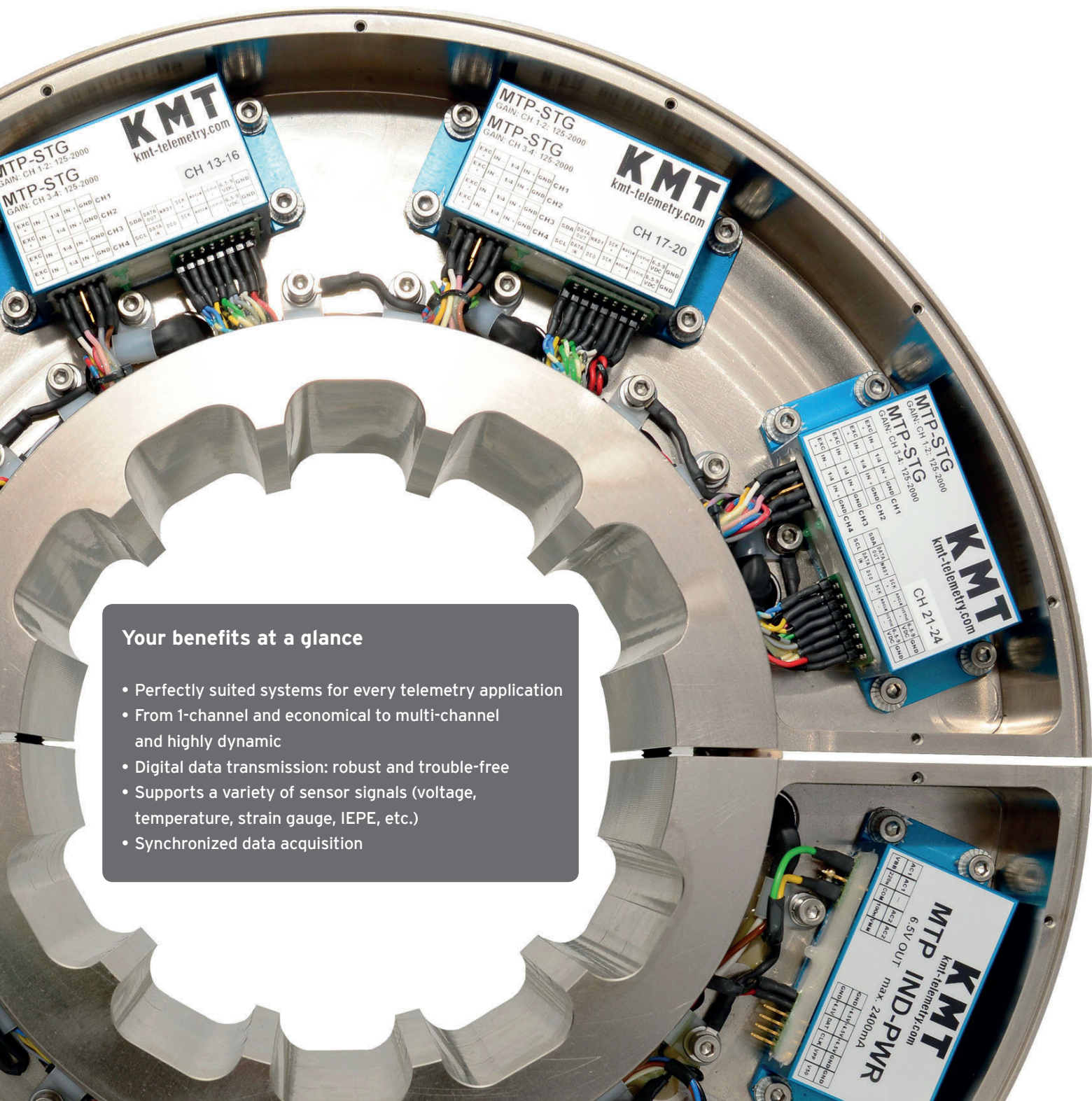

Wireless measurement data transmission in machinery, facilities and vehicles



### Your benefits at a glance

- Perfectly suited systems for every telemetry application
- From 1-channel and economical to multi-channel and highly dynamic
- Digital data transmission: robust and trouble-free
- Supports a variety of sensor signals (voltage, temperature, strain gauge, IEPE, etc.)
- Synchronized data acquisition

# Telemetry: the bridge to your test data

## Advanced telemetry systems for research, development and production

For measurements on rotating components and moving machinery, imc offers modern telemetry systems for a wide variety of tasks: whether single-channel torque monitoring of a rotating shaft, multi-channel strain gauge and temperature measurements on a train wheel-set or non-contact power measurement on a vehicle drivetrain in harsh environments. There are transmission electronics available for a large variety of sensors, such as strain gauge (quarter-, half- and full-bridge), thermocouples, PT100/1000, as well as IEPE sensors and voltage signals.

The telemetry systems are characterized by their robust and compact design, digital and interference-proof data transmission and their clever supply and installation options.

Based on versatile products, we develop tailor-made telemetry solutions for a wide range of application fields: whether in the automotive sector, aerospace, railway, commercial vehicles, marine, wind turbines or industrial facilities - you benefit from our expertise.

### Customer focus and application support

We offer comprehensive services such as consulting, 3D planning, installation support, calibration, strain gauge applications, customer-specific housings and even individual electronics designs.

### Complete solution

For holistic testing on vehicles, wind turbines and machinery it is often necessary to acquire additional measurement variables in addition to the telemetry data. The telemetry solutions allow for a direct connection to imc measurement systems. These instruments provide measurement modules as well as interfaces to typical process and fieldbus systems for all common signals and sensors. The imc system collects and synchronizes these multi-domain data and allows for further processing and analyzing in real time.

Results can then be passed on to overarching systems such as controllers or cloud databases via multiple networking options.



Telemetry for brake testing



Telemetry for train wheel-set test bench



Telemetry for helicopter rotor

# Product Portfolio

## Inductive telemetry systems for short distances up to 50 mm

### T1



#### Miniature 1-channel telemetry for rotating shaft applications

- For one channel
- Signal bandwidth: 0 - 1,200 Hz
- Sampling rate: 0 - 6,410 Hz
- 16 bit resolution
- Modules for strain gauges, PT100
- Strain gauge auto-zero
- Digital data transmission via PCM (inductive)
- Transmission distance: 35 mm
- Inductive power supply
- Dimensions of a transmitter: 35 x 24 x 14 mm
- Operating temperature: -40 ... +85 °C

### MTP-NT



#### Modular multi-channel telemetry for applications on rotating shafts

- For 2 to 256 channels
- Signal bandwidth: 0 - 24,000 Hz
- Sampling rate: 0 - 100,000 Hz
- 16 bit resolution (18 bit internal)
- Modules for analog (voltage, strain gauge, IEPE) and temperature (TH-K, TH-J, PT100/1000)
- Strain gauge auto-zero
- Digital data transmission via PCM (inductive)
- Transmission distance: up to 50 mm
- Inductive power supply
- Dimensions of a module: 60 x 40 x 10 mm
- Operating temperature: -40 ... +85 °C (125 °C)

### TEL1-PCM-FLEX

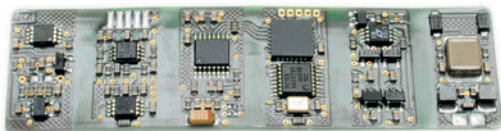

Flexible and pliable 1-channel telemetry for strain gauge measurements in confined spaces

## Radio telemetry systems for medium distances up to several meters

### CTP



**Universal high-speed telemetry for 4 - 16 channels with high bandwidths**

- For 4 to 16 channels
- Signal bandwidth: 0 - 24,000 Hz
- Sampling rate: 0 - 62,500 Hz
- 16 bit resolution
- Universal inputs for strain gauge, TH-K, PT100 and voltage
- Strain gauge auto-zero
- Digital data transmission via radio (diversity-reception)
- Transmission distance: up to 2000 m
- Power supply: 10 - 30 V DC
- Dimensions: 90 x 90 x 52 mm (CTP4)
- Operating temperature: -20 °C ... +70 °C

### CTP-Rotate



Compact and waterproof variant for wheels and rotors with 4 - 64 channels

### D<sup>x</sup>



**Universal, compact telemetry for distributed measurements with up to 4 synchronous transmitters per receiver**

- For 6 to 24 channels
- Signal bandwidth: 0 - 920 Hz
- Sampling rate: 0 - 4.600 Hz
- 16 bit resolution
- Universal inputs for voltage, strain gauge, TH-K
- Strain gauge auto-zero
- Programmable amplification
- Digital data transmission via radio (diversity-reception)
- Transmission frequency 868 MHz band with 13 frequencies
- Transmission distance: up to 10 m
- Inductive, battery power supply
- Transmitter dimensions: 45 x 25 x 10 mm
- Operating temperature: -40 °C ... +85 °C

### D<sup>x</sup>-HT

- Signal bandwidth: 0 - 1,000 Hz
- Sampling rate 0 - 5,000 Hz
- Transmission frequency 2.4 GHz band with 17 frequencies
- Operating temperature: -40 °C ... +125 °C

# T1

## Digital 1-channel telemetry

The 1-channel telemetry system T1 is ideal for wireless transmission of strain gauge signals from rotating shafts. The transmitter electronics allow the direct connection of strain gauges in full- and half-bridge mode. The bridge supply is fixed 4 Volt DC and the gain can be freely selected in 4 levels. The transmitter electronics (encoder) is only 35 mm wide, 18 mm long and 12 mm deep and weighs only 13 grams.



### Simple installation

In a matter of minutes, the transmitter can either be attached to the shaft using a special glass-fiber-reinforced tape, or it can be installed directly in a ring housing made for the shaft.

### Wireless transmission and power supply

The power supply to the transmitter side and the digital data transmission to the receiver operate inductively. The T1 encoder generates a digital signal by means of pulse-code modulation (PCM), which is transmitted to the receiver head via an induction winding around the shaft. From there, the signal is sent via cable to the receiver unit. The maximum distance between the transmitter coil and the receiver/power supply head is up to 35 mm.

### Receiver unit

The receiver unit provides an analog output (+/- 10 V) on the front side as standard and can also be equipped with a current loop (4 ... 20 mA). An automatic zero adjustment (auto-zero) can be triggered by pressing the AZ button on the front of the receiver.

At a glance	
channels	1
signal bandwidth	0 - 1,200 Hz
input types	strain gauge, PT100
resolution	16 bit
transmission	inductive
power supply	inductive
housing	robust und water resistant
operating temperature	-40 ... +85 °C
transmitter weight	13 g
transmitter dimensions	35 x 24 x 14 mm

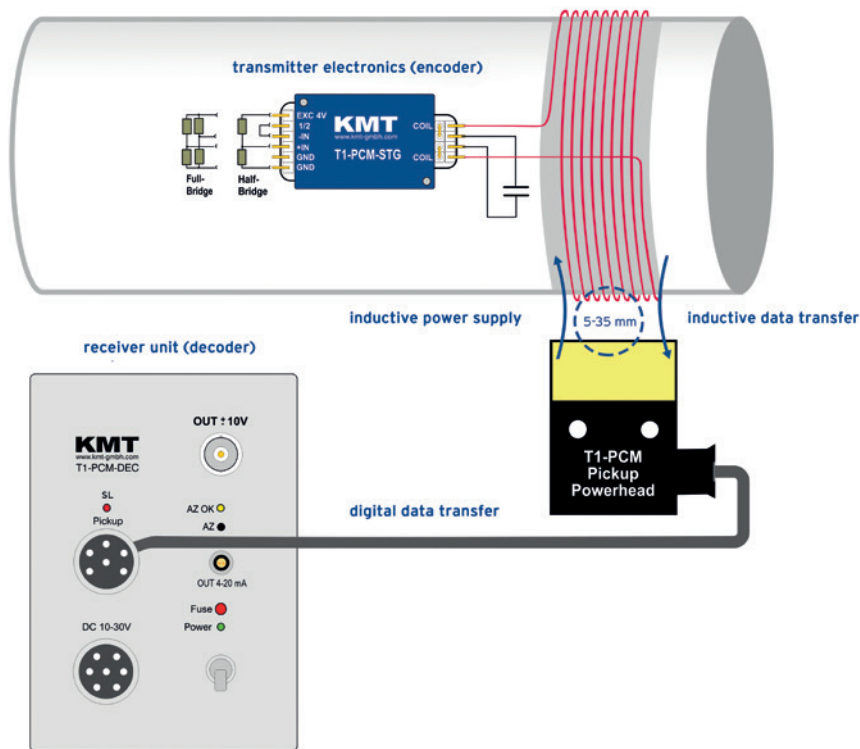

## The flexible telemetry TEL1-FLEX

The TEL1-FLEX offers users a telemetry series for particularly cramped quarters. The extremely flat and flexible transmitter electronics allow torque measurements under the tightest installation conditions. The total thickness is less than 2 mm. Thanks to the space-saving design based on a pliable film substrate, the flexible telemetry makes it extremely easy to apply to rotating shafts or other machine components.

The TEL1 telemetry transmits its data digitally and inductively with a resolution of 12 bits to the TEL1 receiver head. A cable connects it to the TEL1 receiver. For signal output, an analog output (+/- 10 V) is available as standard. Optionally, a current loop (4 ... 20 mA) can also be integrated.

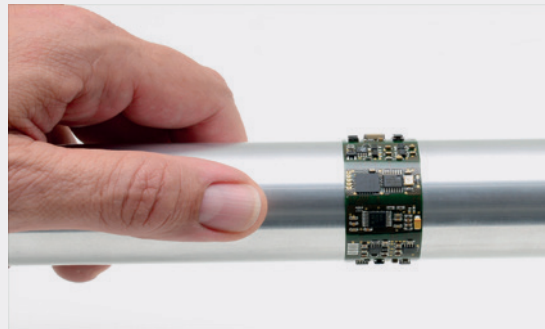
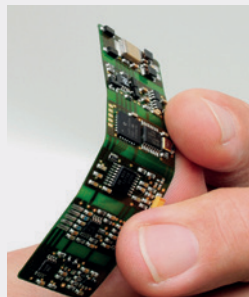

At a glance	
channels	1
signal bandwidth	0 - 1,200 Hz
input types	strain gauge
resolution	12 bit
transmission	inductive
power supply	inductive
housing	flexible circuit board
operating temperature	-40 ... +80 (125) °C
transmitter weight	2 g
transmitter dimensions	70 x 20 x 2 mm

# MTP-NT

## Modular telemetry

MTP-NT telemetry is a small and flexible telemetry system that has a modular design. It consists of freely selectable sensor modules, a controller module and an inductive transmitter unit. Depending on the needs of the user, the telemetry system can be freely assembled and subsequently adapted.



### The right module for every sensor type

MTP-NT telemetry offers two module types for sensors: a universal analog module for voltage, strain gauge (quarter-, half- and full-bridge) and IEPE sensors and a temperature module for measuring thermocouples (Type K and Type J) and PT100/1000. Each sensor module is available in a 2-channel or 4-channel version and is equipped with signal conditioning, anti-aliasing filters, A/D converters and a digital output.



### Multiple modules, only one controller

Up to 128 modules (256 channels) can be controlled with a single MTP-NT controller module. The modules can be placed close to the sensors and connected to each other over longer distances of up to 10 m via interference-free digital outputs. This avoids unwanted noise. The output of the MTP-NT controller is a bit-serial PCM signal that is modulated for wireless transmission and can be transmitted inductively over distances up to 50 mm. It is designed for data rates up to 10 Mbit/s.





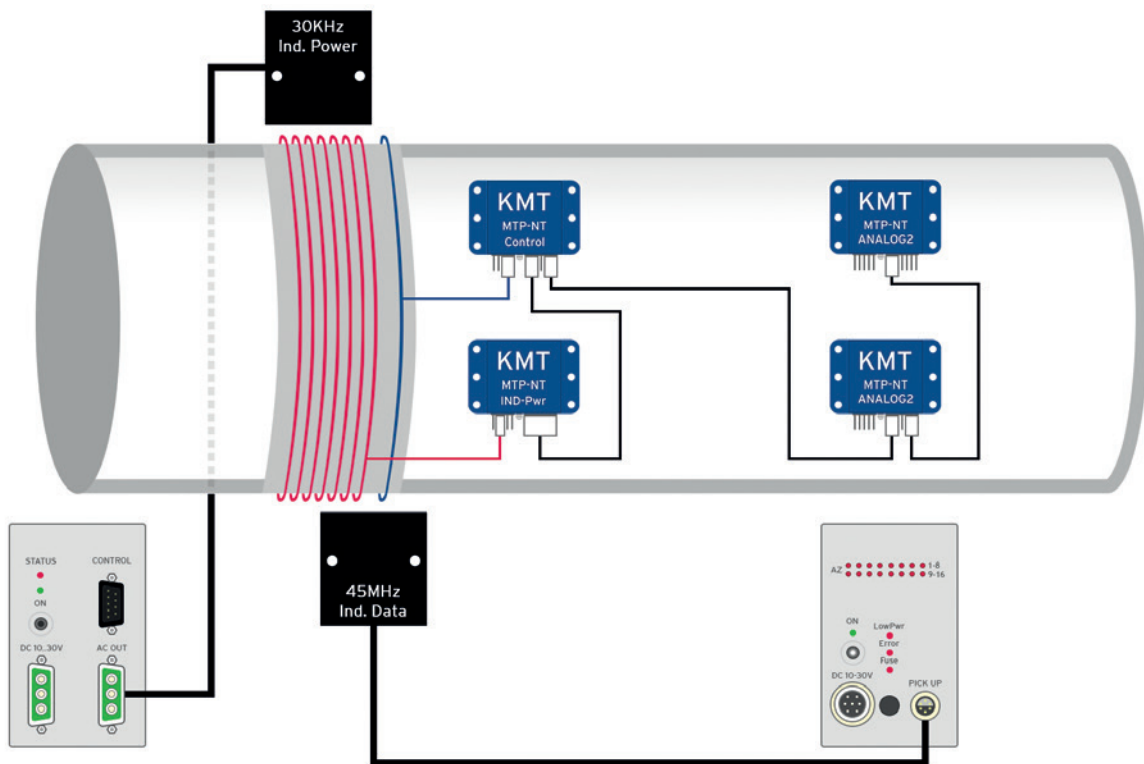

### Wireless transmission

Depending on the application, different non-contact transmission links are available, e.g., an inductive coil antenna for distances up to 50 mm and a transmission rate of up to 10 Mbit/s. This allows, for instance, for 32 parallel channels, a signal bandwidth of up to 6,000 Hz and a corresponding 24,000 Hz with eight channels.

### Wireless power supply

For permanent installations, e.g., in test benches or production facilities, telemetry often has to work uninterrupted for days or weeks. For this purpose, the MTP telemetry uses a non-contact, inductive power supply. Using a stationary inductive head and a receiver coil on the rotating component, the supply voltage for telemetry is transmitted without contact.

### Receiver unit

In the MTP-NT receiver unit, all data from the transmitter modules converge. Via an Ethernet interface, the data can be forwarded to a higher-level system. An integrated solution is provided by the imc measurement systems with TELDEC interface, which ensure a time-synchronous acquisition of telemetry and all other

sensors and systems connected to the imc system.

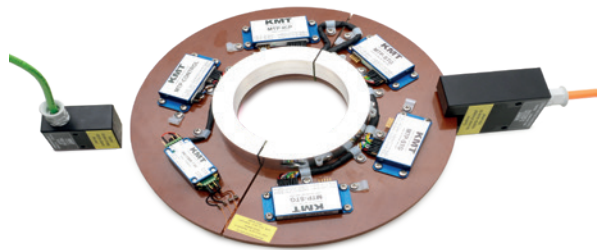

At a glance	
channels	2 - 256
signal bandwidth	0 - 24 kHz
input types	strain gauge, TH-K, PT100, PT1000, IEPE, voltage
resolution	16 bit (18 bit internal)
transmission	inductive
power supply	inductive
housing	robust and water resistant
operating temperature	-40 ... +85 (125) °C
module dimensions	60 x 40 x 10 mm

# CTP

## High-speed wireless telemetry for up to 16 channels

The modular telemetry system CTP enables the acquisition, processing and transmission of 4, 8 or 16 parallel measurement signals from stationary or moving machines and vehicles, such as in Pass-By-Noise testing.

The processed signals digitized with 16-bit resolution are transmitted wirelessly to the receiver unit via a robust and interference-free radio link. Depending on the bit rate, transmission power and antenna types, distances of up to 2000 m in free field are possible. The PCM format of the measurement data ensures optimum interference immunity. The power supply is external with 10 to 30 VDC.



## Especially comfortable configuration

Each channel can be easily configured on a PC via the LAN adapter with integrated web interface. The selection of the measurement range, automatic zeroing and internal shunt calibration on a PC via the web interface.

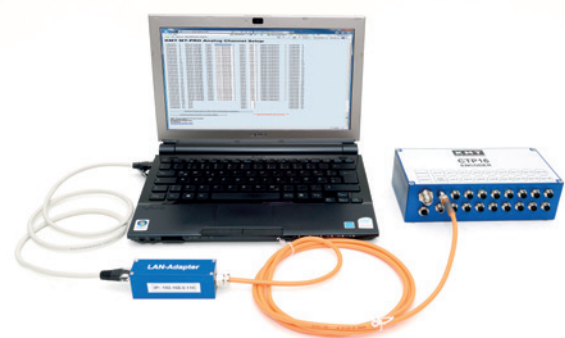

## Variant for rotating applications with up to 64 channels

The CTP-Rotate telemetry system enables the acquisition, processing and transmission of 4, 8, 16, 32 or 64 parallel measurement signals from rotating machinery, test benches, wheels and rotors. The integrated accumulator unit allows easy and quick installation of telemetry. The weatherproof system designed for outdoor use (IP65) enables data transmission over distances of up to 20 meters in free fields.



## Receiver unit

The stationary receiver unit (decoder) has two antenna connections for optimum reception of the RF signals. Thanks to the robust design, the receiver can withstand vibrations of up to 100 g and operates over a wide temperature range from -20 to +70 °C. The telemetry data are output either via analog outputs (+/- 10 V) or via the optional decoder with Ethernet interface. In conjunction with an imc measurement system with TELDEC-interface, high-precision, time-synchronized data acquisition can be implemented with many other sensors and bus systems.



At a glance	
channels	4/8/16/32/64
signal band width	0 - 24,000 Hz
input types	strain gauge, TH-K, PT100, PT1000, IEPE, voltage
resolution	16 bit
transmission	radio
power supply	battery
housing	robust and water-resistant
operating temperature	-20 ... +70 °C
receiver unit dimensions:	
CTP4/8/16	L = 90, W = 90/125/185, H = 52mm
CTP4/8-Rotate	diameter 145 x 62 mm
CTP16-Rotate	diameter 190 x 70 mm
CTP32-Rotate	diameter 250 x 80 mm
CTP64-Rotate	diameter 260 x 77 mm

# D<sup>x</sup>

## Universal telemetry for up to 24 channels

D<sup>x</sup> telemetry is a particularly compact and lightweight multi-channel telemetry. Thanks to the universal transmitter module, it can be used flexibly and enables wireless measurements with different numbers of channels and sensor assignments. The possibility of operating up to four transmitters synchronously with one receiver allows for simultaneous acquisition of spatially distributed measurement points.

### Universal transmitter unit

The 14 g light and compact D<sup>x</sup> transmitter unit contains the complete signal conditioning and digitizing for up to 6 channels, as well as an integrated antenna for radio transmission. The module allows for direct connection of different sensor types. Thus, up to four low-voltage signals such as half-bridge, full-bridge or thermocouples can be connected and transmitted, as well as two voltage signals up to +/- 22.5 V.



### Receiver unit

A special feature of D<sup>x</sup> telemetry is that the receiver unit can acquire data from up to 4 transmitter modules synchronously. This allows up to 24 channels to be acquired and transmitted synchronously. As outputs, the receiver offers an Ethernet and a CAN interface as well as analog outputs. The configuration can be done easily via Ethernet and a standard web-browser.



## Flexible power supply

Several flexible solutions are available for supplying power to the transmitter modules: an inductive head or an inductive ring stator allow continuous operation. Alternatively, the use of various battery variants ensures a secure supply for hours (up to days) - also optionally with UPS.

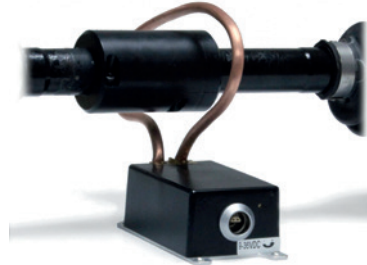

## Easy installation thanks to shaft housing

Frequently, D<sup>x</sup> telemetry is used to detect the torque of driven axles. Especially for this application, we offer a divisible shaft housing for quick assembly. This housing protects the strain gauge application and the transmitter electronics, already contains the secondary coil for inductive power supply and can be reused.



## Integrated power measurement

Based on the shaft housing, users also have access to an innovative complete system for measuring the power of rotating components: in addition to the torque, the velocity of the shaft is acquired simultaneously and the power is calculated online from these two quantities. Since the sensors for velocity acquisition are completely integrated within the shaft housing, the robust system can detect angles with no additional stator head.



At a glance	
channels	6 - 24
signal bandwidth	0 - 1,000 Hz (with HT)
input types	strain gauge, voltage, thermocouples
resolution	16 bit
transmission	digital "diversity" reception
power supply	battery, inductive
housing	robust and water resistant
operating temperature	-40 ... +85 (125) °C
transmitter dimensions	45 x 25 x 10 mm

# In Practice

## Vehicles

For applications in the automotive industry, imc offers robust and compact wireless telemetry systems for the non-contact transmission of measurement data for torsion, temperatures, forces and vibrations of rotating parts on vehicles.



Force measurement on a car wheel with CTP-Rotate

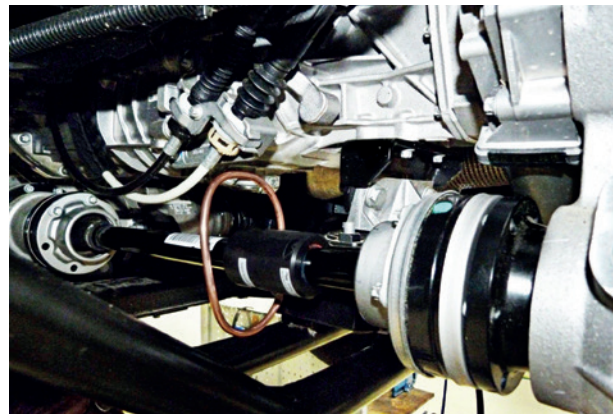

Torque measurement on a drive shaft with D<sup>x</sup>

## Aerospace

For use on helicopters and aircraft, imc offers robust radio telemetry systems with up to 64 channels. The systems are specially designed for mounting on rotating parts, e.g., rotors, propellers, wheels or other rotating machinery. All measurements are simultaneous and the signals are digitally transmitted wirelessly. All transmitter electronics are protected from water according to IP65 and the sensors, e.g., strain gauges, thermocouples, PT100/1000 or IEPE are connected via waterproof connectors.



Force and vibration measurements on aircraft propellers



Application on ultra-light helicopter

## Rail

Railway applications require particularly robust telemetry solutions, such as when testing axles, drive, motor and gear shafts or other rotating powertrain components. Up to 256 sensor signals, e.g., strain gauges, thermocouples or vibration sensors can be detected and transmitted simultaneously. The space-saving, non-contact transmission technology simplifies the implementation of the measurement system and ensures the most accurate measurement results.



Force measurement on railway wheel set

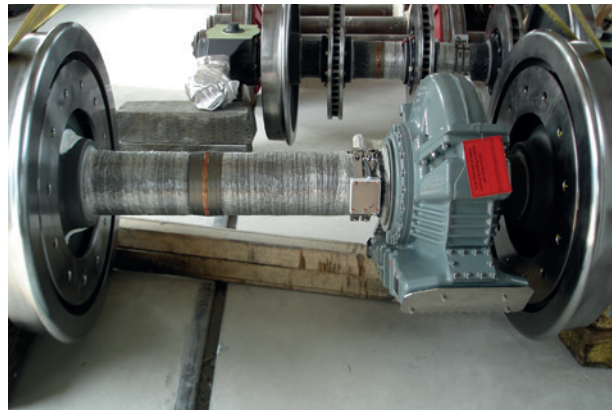

Temperature measurement on train brake disk

## Marine

Our telemetry systems for torque measurements on marine vessels and engines are easy to install and are available in various sizes - matching the drive shaft. Depending on the particular measurement task, single or multi-channel systems can be used. Many powertrain components of ships, such as gear shafts, have been successfully tested with imc telemetry solutions to optimize their performance, efficiency and cost-effectiveness.

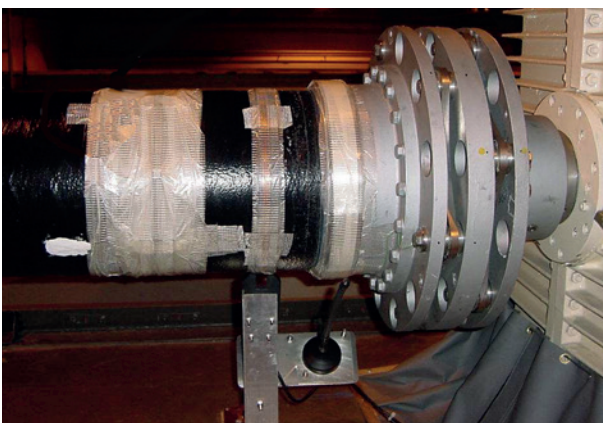

Torque measurement on ship drive shaft

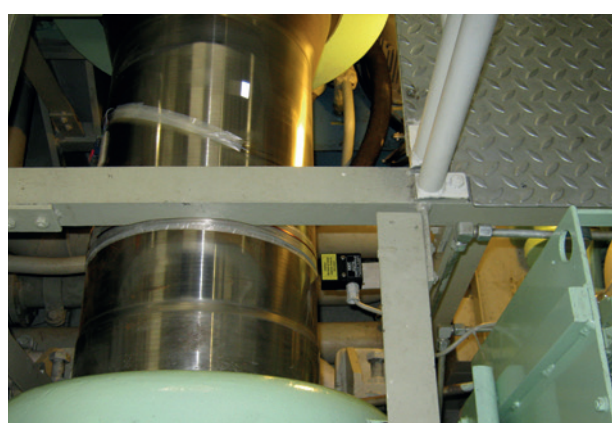

Telemetry system in operation

## Mechanical Engineering

Whether on motors and generators, machine tools, rolling mill drives, paper machines, marine drives or wind turbines: these telemetry systems allow for non-contact transmission of measurement variables, such as torque, force, pressure, vibration and temperature. Measurement systems with up to 256 channels and data rates of up to 10 Mbit/s are available.

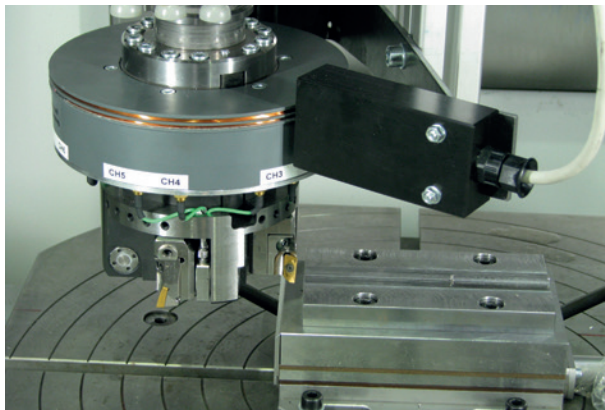

Force measurement on milling machine

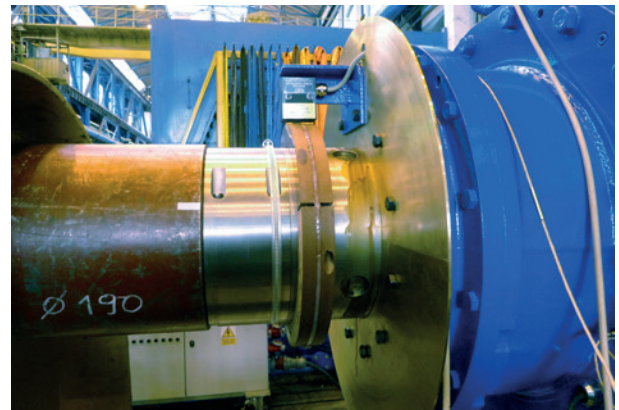

Torque measurement on drive shaft

## Wind Energy

For applications on wind energy systems, imc offers flexible telemetry solutions that support users in a wide variety of tasks: whether to measure torsion and bending moments on a wind turbine's main or generator shaft or to determine side load, rotor position and blade angle on a rotor blade.

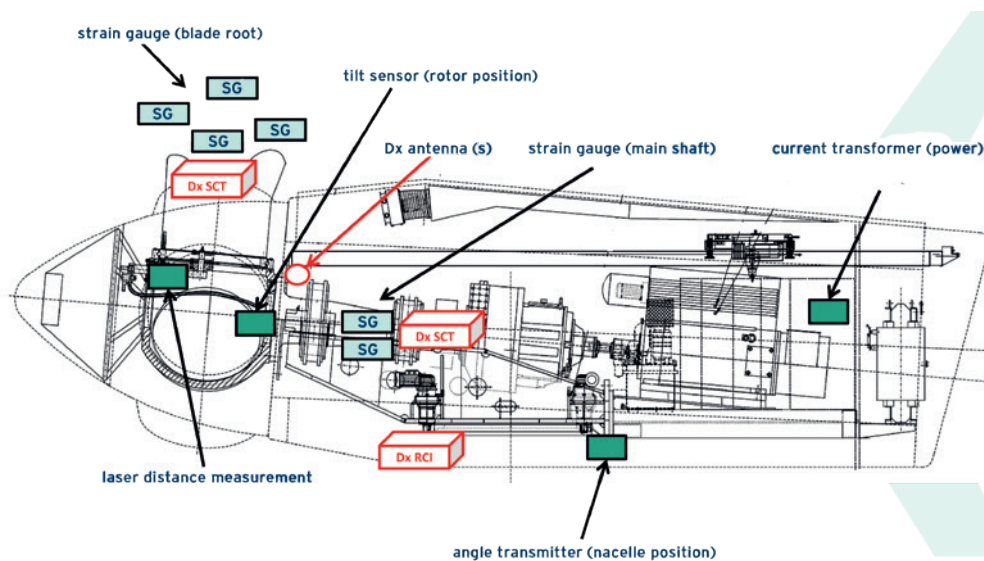



## Commercial Vehicles

The demands on modern heavy-equipment such as excavators, wheel loaders, forklifts and agricultural machinery are high. In addition to robustness, efficiency plays an increasingly important role. When optimizing drive systems, telemetry solutions can help. Measurements such as torque, efficiency, temperature, pressure, traction and bending can be acquired without contact by the telemetry systems.



Torque measurement on combine harvester

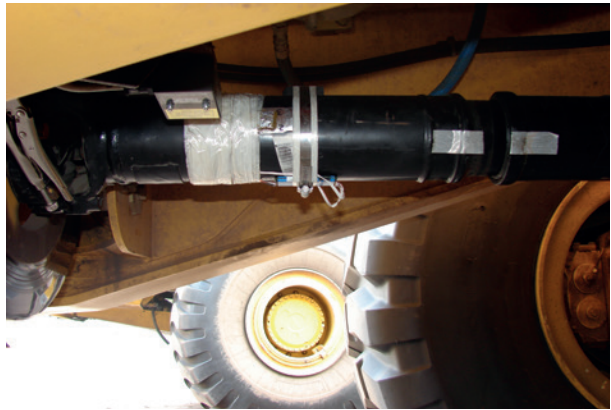

Measurement of torque on dump truck

## Test Stands

The telemetry systems are ideally suited for continuous use in test mode. They detect non-contact torques and vibrations on drivetrains, transmit the temperature of brakes, tires and wheels, and record forces on gearbox and clutch test stands. The high data rate of up to 10 Mbit/s ensures reliable transmission, even with dynamic sensor signals.

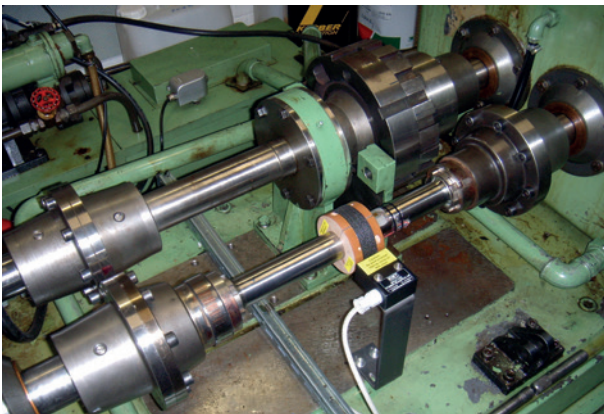

Measurement of torque on the gearbox test bench

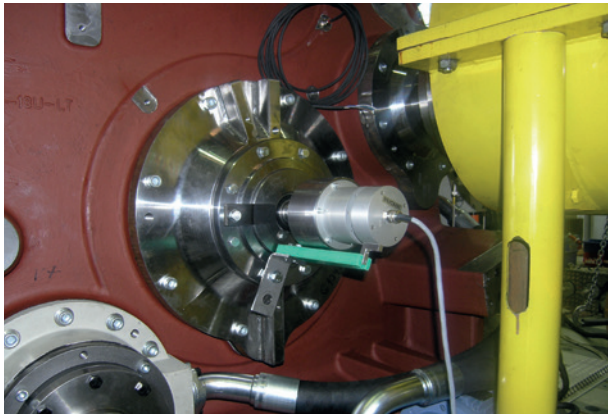

Force measurement with large gearbox test bench

# Technical Data

		T1	TEL1	TEL1-FLEX
application		one channel	one channel	one channel
distinction		economical	economical	flexible
max. channels per transmitter		1	1	1
max. channels per decoder / system		1	1	1
<b>technology</b>				
data transfer		inductive	inductive	inductive
reach		35 mm	35 mm	35 mm
resolution		16 bit	12 bit	12 bit
<b>power supply</b>				
inductive		●	●	●
battery				
10 - 30 V DC				
<b>output (decoder)</b>	<b>data acquisition with Imc</b>			
analog +/- 10V	via voltage input	●	●	●
CAN	via CAN interface			
Ethernet	via TELDEC interface			
<b>configuration (parameterization)</b>				
Ethernet				
USB/RS232				
<b>data rate per transmitter</b>				
max. signal bandwidth		1.2 kHz	1.2 kHz	1.2 kHz
max. sampling rate		6.4 kHz	7 kHz	7 kHz
max. data rate				
<b>measured quantities and sensors</b>				
voltage		●	●	
IEPE				
strain gauge bridges		full / half	full / half	full / half
thermocouple			●	
PT100/PT1000		●		
<b>operating conditions</b>				
transmitter		-40 ... +85 °C	-40 ... +85 °C	-40 ... +85 (125) °C
receiver		-20 ... +70 °C	-20 ... +70 °C	-20 ... +70 °C

		MTP-NT	CTP	CTP-Rotate	D <sup>x</sup>	D <sup>x</sup> - HT
application		multi-channel	multi-channel	multi-channel	multi-channel	
distinction		modular	mobile	mobile & rotating	modular	
max. channels per transmitter		2/4	4, 8, 16	4, 8, 16, 32, 64	4+2	
max. channels per decoder / system		256	16	64	24	
<b>technology</b>						
data transfer		inductive / radio	radio	radio	radio	
reach		50 mm	2000 m	20 m	10 m	
resolution		16 (18) bit	16 bit	16 bit	16 bit	
<b>power supply</b>						
inductive		•			•	
battery		•		•	•	
10 - 30 V DC			•			
<b>output (decoder)</b>	<b>data acquisition with Imc</b>					
analog +/- 10V	via voltage input		•	•	•	
CAN	via CAN interface				•	
Ethernet	via TELDEC interface	•	•	•		
<b>configuration (parameterization)</b>						
Ethernet			•	•	•	
USB/RS232		•				
<b>data rate per transmitter</b>						
max. signal bandwidth		24 kHz	24 kHz	24 kHz	920 Hz	1 kHz
max. sampling rate		100 kHz	62.5 kHz	62.5 kHz	4.6 kHz	5 kHz
max. data rate		10 Mbit/s	5 Mbit/s	5 Mbit/s		
<b>measured quantities and sensors</b>						
voltage		•	•	•	•	
IEPE		•	•	•	•	
strain gauge bridges		full / half/ quarter	full / half/ quarter	full / half/ quarter	full / half	
thermocouple		•	•	•	•	
PT100/PT1000		•/•	•/•	•/•	•/•	
<b>operating conditions</b>						
transmitter		-40 ... +85 (125) °C	-20 ... +70 °C	-20 ... +70 °C	-40 ... +85 °C	-40 ... +125 °C
receiver		-20 ... +70 °C	-20 ... +70 °C	-20 ... +70 °C	-20 ... +65 °C	-20 ... +65 °C

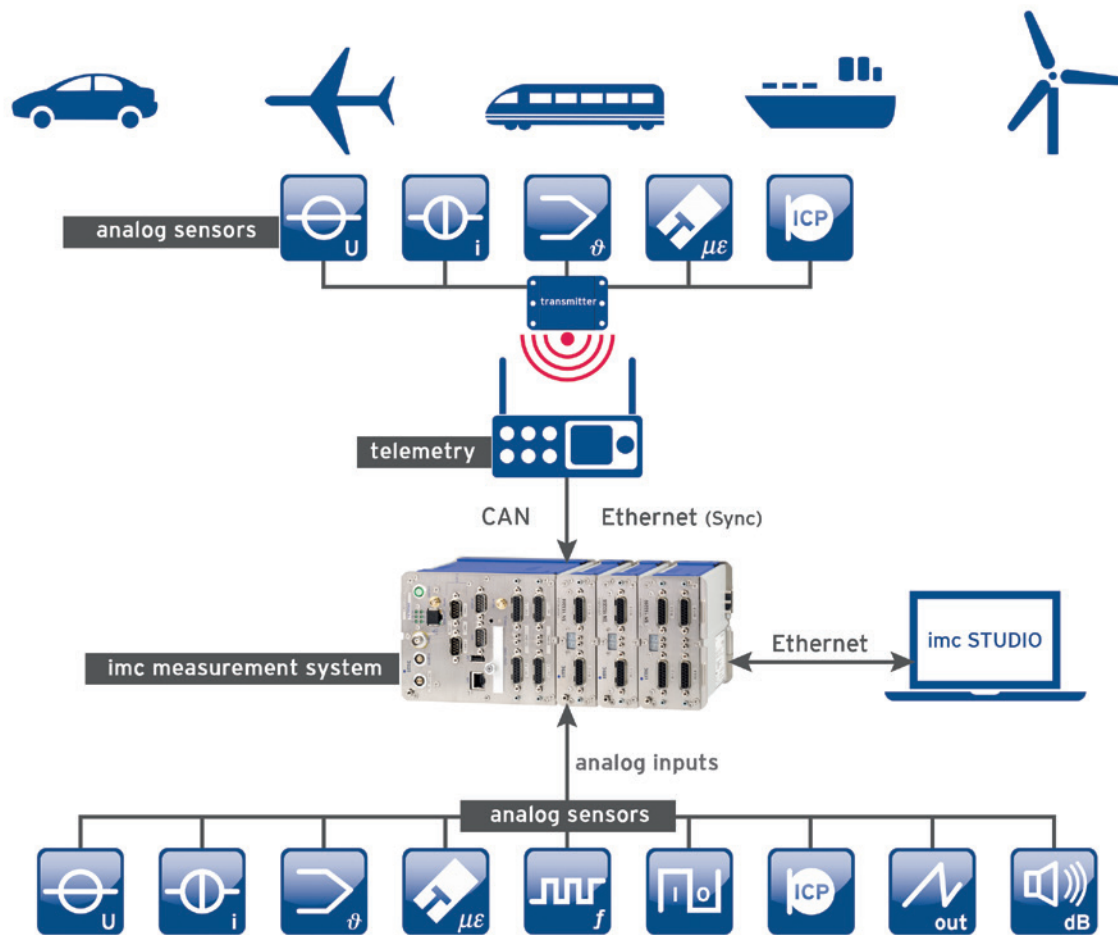

**imc Test & Measurement GmbH**

Voltastraße 5  
13355 Berlin  
Germany

Tel.: +49 (0)30 - 46 70 90 0  
Fax: +49 (0)30 - 463 15 76  
hotline@imc-tm.de  
www.imc-tm.com