

imc CRONOS-XT

robust • mobile • scalable



Highly robust and clickable DAQ system for harsh environments

imc CRONOS-XT - at a glance

- Water- and dustproof according to IP67
- Shock and vibration resistant to military standard MIL-STD-810F
- Modular building blocks with **click connector** for flexible assembly
- **2 MS/s** system rate and 100 kS/s per channel
- Special and **universal measurement amps** for the connection of almost all sensor types
- **Fieldbus** interfaces for CAN, LIN, CAN FD, etc. as well as telemetry interface
- Live data analysis with **imc Online FAMOS**
- **Autarkic** and self-starting as well as Wake-Up on CAN
- **Position data** via GPS connection
- Integrated web server and **cloud** connectivity



imc CRONOS-XT

Clickable, robust data acquisition system for mobile measurements

No more compromises: With the imc CRONOS-XT, imc is offering for the first time an ultra-robust device in a completely modular platform. The data acquisition base unit and a number of amplifiers can be conveniently connected to form a complete system: without tools and cables via a simple click-mechanism. With protection class IP67 and MIL-STD810F, the system is protected against dirt, dust and water as well as severe shocks and vibrations. The robust data logger is therefore ideal for mobile measurements on construction machinery, tractors, agricultural machinery and vehicle testing that takes place in harsh environments.

Thanks to the modular building block technology, the DAQ system can be ideally adapted to the measurement task at hand. A broad selection of high-precision universal and special measurement amplifiers allow the direct connection of almost all sensor types, such as thermocouples, RTD (PT100/1000), voltage and current signals, acceleration and sound sensors

(IEPE), displacement transducers (LVDT), all the way to strain gauges as full/half/quarter bridges and corresponding bridge sensors such as load cells. The precise and low-noise measurement amplifiers digitize with 24 bits and have high bandwidth and range dynamics.

In addition to the recording of raw data at high rates, the integrated computing platform imc Online FAMOS enables calculations and processing in real time. Thus raw data can be live analysed and pre-compressed. Statistical functions and various online analyzed such as FTT, class counting and order tracking are also available. This makes it possible for users without special knowledge to create complex evaluation algorithms without programming and to set up smart data analyses.

In addition to analog measurement inputs, imc CRONOS-XT offers a variety of fieldbus interfaces so that data from CAN, LIN, CAN FD, FlexRay, XCPoE and many other bus systems can be synchronously recorded.



Your benefit - our goal



Extremely robust

- Waterproof and dustproof according to IP67
 - High vibration and shock resistance according to MIL-STD-810F
 - Robust, impact-resistant housing
 - Sealed electronics (condensation-proof)
 - Wide temperature range from -40 °C to +85 °C
-



Especially flexible

- Building block system: Modular DAQ system can be assembled flexibly with base unit, measurement modules, handles and power module
 - Click-mechanism allows tool-free assembly in seconds - no cables required
 - Can be used both as a centralized system and spatially distributed
-



Precise and fast

- 24 bit universal amplifiers measure voltage, current, thermocouples, PT100, IEPE and quarter/half/full bridge signals - sensor supply included
 - Highly dynamic measurements with 2 MS/s aggregate sampling rate and 100 kS/s per channel
 - Edge Computing: On-board live data analysis delivers real-time results
-



Autarkic and mobile

- Autarkic data logger operation without PC
 - Robust real-time operating system designed for 24/7 continuous operation
 - Reliable data storage on internal CFast memory card
 - Self-starting and Wake-Up on CAN functionality
-



Networked

- Gigabit Ethernet interface for real-time data transfer and visualization
- Optional dual-band Wi-Fi
- GPS interface for geodata and synchronization
- Synchronization of multiple devices: with μ s precision and also via network
- Fieldbus interfaces for all relevant industrial and vehicle buses including CAN, CAN FD, Flex Ray, XCPoE, EtherCAT, and many more
- Decoding and processing of ECU protocols such as CCP, XCP, KWP2000, UDS

In Practice

Testing under harsh conditions

The stress that is imposed on machines for construction and agriculture can be enormous. This makes it all the more important to carry out comprehensive functional and stress tests when developing such machinery. imc CRONOS-XT provides test and measurement engineers with the perfect tool for such tasks. Universal measurement amplifiers precisely measure all sensors installed on the machine including strain gauges, IEPE/ICP, displacement, force and pressure and perform real-time analyses, e.g., for rosette calculations or spectral analysis (FFT). The robust housing reliably protects the equipment from dust, dirt, water and mud.



Keeping track of noise and vibration

To protect both people and the environment from noise, vehicles and machinery must comply with many regulations. These not only include noise emissions, but also vibrations affecting people and components. With imc CRONOS-XT in conjunction with imc WAVE software, users have a complete package for noise and vibration analyses at their disposal: From noise measurements during road tests through structural analyses on the test bench to vibration tests in the field.



Fatigue testing and load profiles

The imc CRONOS-XT provides test engineers with the ideal system for acquiring live road load data and operate fleet monitoring. Thanks to the high shock and vibration resistance according to MIL-STD-810F, imc CRONOS-XT is able to reliably record test data even under extreme conditions. Functions such as self-start, online class-counting, GPS tracking and cloud connection for measurement data transfer and online monitoring are particularly helpful for week-long test drives.



Modular Design

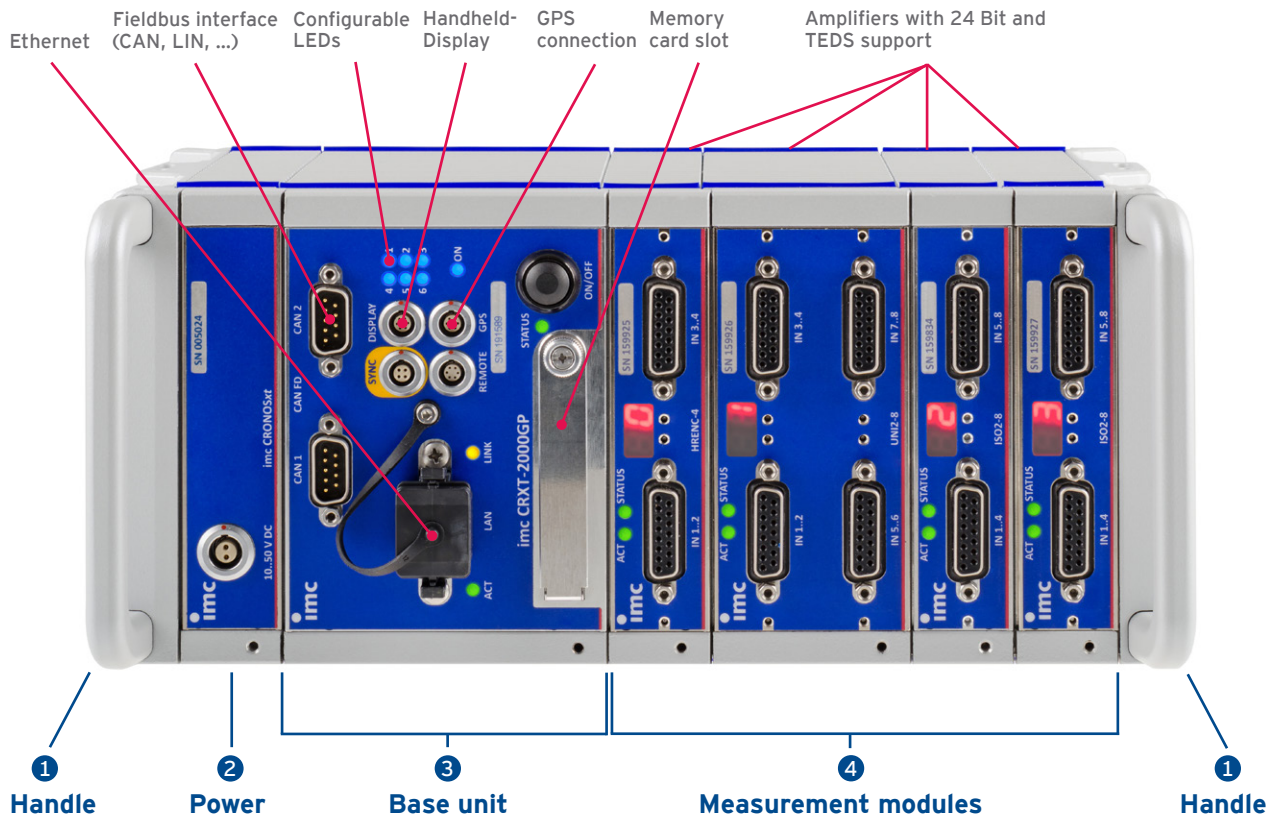

1 Handle

Robust carrying handles for easy handling offer protection at the same time.

3 Base unit

Logger module with central data management including memory slot, synchronization, networking options and real-time platform for analysis and control.

2 Power

Power supply module with wide-range input (10-50 V DC), options for UPS functionality and EtherCAT interface for distributed systems.

4 Measurement modules

Various module types with precision analog amplifiers for almost all sensor types, modules with digital inputs and outputs as well as counter/encoder inputs.

Distributed system design of the imc CRONOS-XT

Solution 1: Single device in distributed topology

In addition to the modular design as a centralized system, imc CRONOS-XT can also be installed in a spatially distributed topology. This allows measurement amplifiers to be placed close to the sensor in order to keep the length of sensitive and expensive cables to a minimum. Networking is accomplished via the EtherCAT-based imc system bus. All data converge synchronously in the base unit.

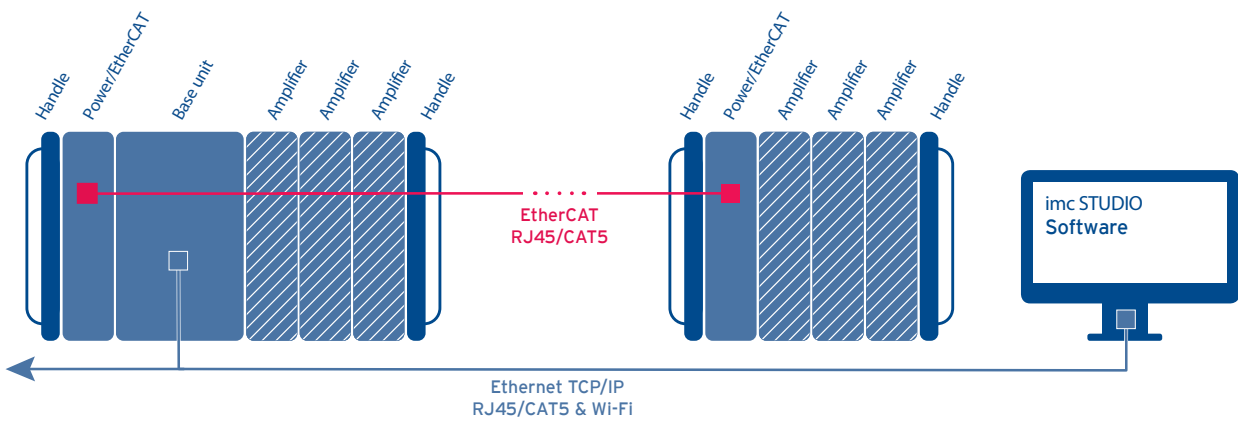

Solution 2: Multiple networked devices

For extensive measurements with hundreds or thousands of channels, multiple imc CRONOS-XT, as well as all other imc measurement devices, can be operated together as a single system. The devices are networked via Ethernet and synchronized via DCF77, IRIG-B, GPS or PTP. The data are stored autonomously in the devices or transferred to a NAS or PC via network streaming.

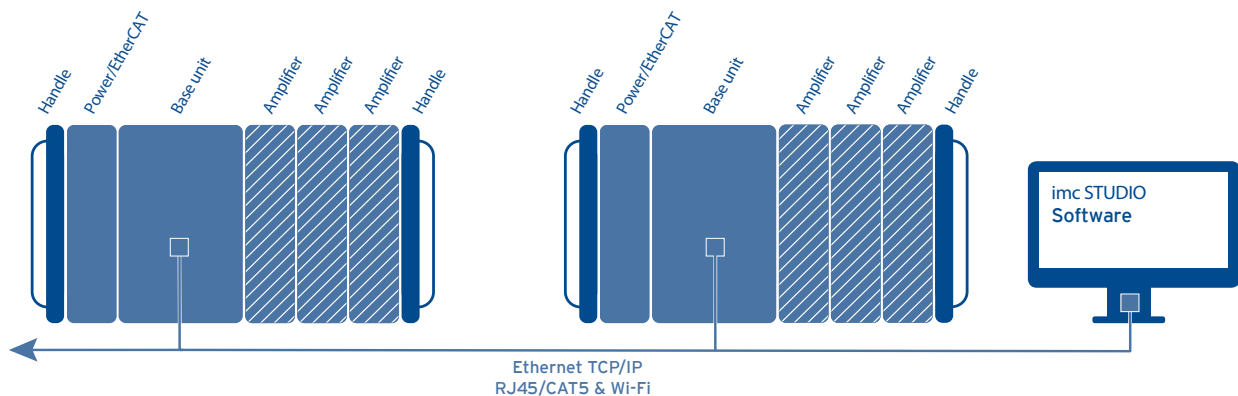

One software for the entire testing process

imc STUDIO combines data acquisition, visualization, analysis and automation

No matter whether you want to configure your imc CRONOS-XT for a fast mobile measurement in “black box” mode, set up live monitoring for hundreds of channels for prototype testing or create a complete test bench automation with your own control panel - with imc STUDIO you have full control over your complete measurement process: from channel configuration to report.

Configure and measure

With imc STUDIO, you are ready to start your measurement in a few minutes. A clearly organized channel configuration list, extensive sorting and filtering functions, numerous assistants, built-in sensor management and support of TEDS are just some of the useful functions that will help you reach your goal faster.

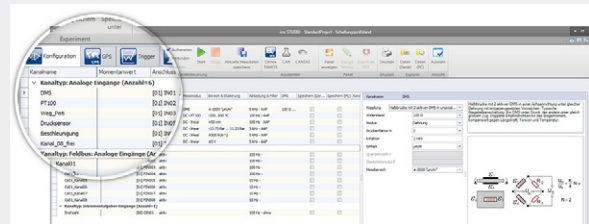

Data display and system operation

With just a few mouse clicks, you can design tailor-made user interfaces with the imc STUDIO Panel, and link them to the system's inputs and outputs. Choose from over 100 predefined instrument templates and elements (widgets) to create your own personal test and measurement interface.

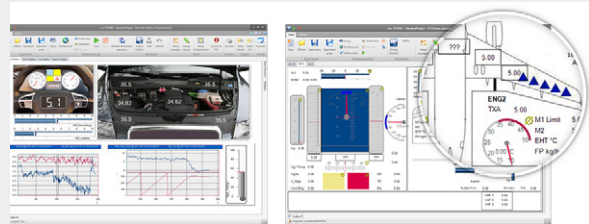

Automating routine tasks

Save time by automating routine measurement processes using imc STUDIO. Use the drag & drop technique to create your own personal test sequence by selecting from a wide variety of functions - such as channel balancing, entering test object data, starting measurements, saving data, running analyses and printing out a report. That's it!

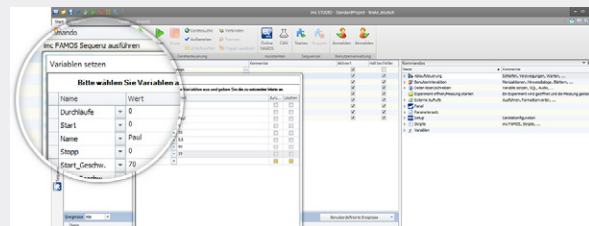

Recording and playback of videos

Synchronous video recording of your measurement data is child's play. Simply connect a video camera, and imc STUDIO will take care of the rest. Like any measurement channel, the video channel is synchronized, and offers pre- and post-triggering and even two independent instances (entities) with different data rates and trigger settings (“monitor channels”) for each camera.

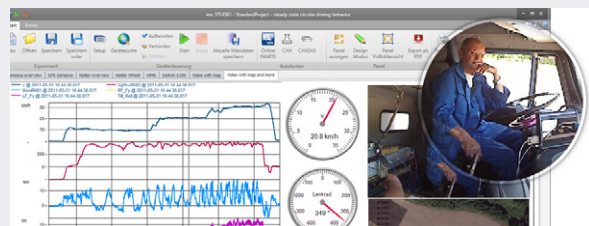

Easy test stand automation

Take control. With imc STUDIO you independently create complete real-time automations for test benches and test setups - without programming a line. You define the individual process steps and add ready-made functions to setpoints, logical controls or complex multi-variable control via drag & drop.

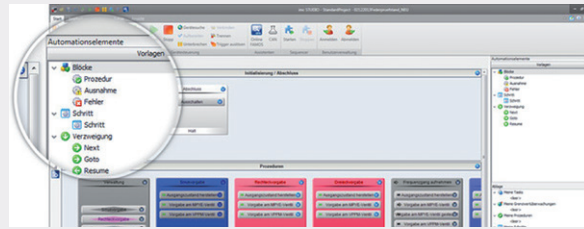

Live analyzing

Save time and analyze your measurement data live with imc Online FAMOS (device-based) or imc Inline FAMOS (PC-based). If you carry out statistical evaluations, mathematical calculations or complex analyses while the measurement is still running, you will receive meaningful results in real time and can react immediately - even during the test.

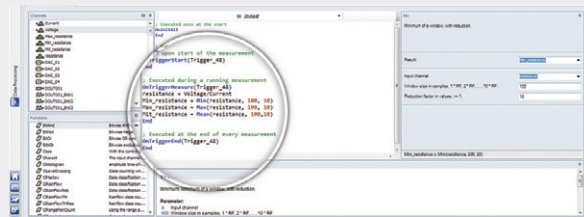

Post-process data analysis

imc FAMOS combines all the tools you need for professional visualization and evaluation of your measurement data: from importing the data to printable reports. Numerous ready-to-use analysis functions and powerful automation options ensure professional measurement data evaluation and fast results.

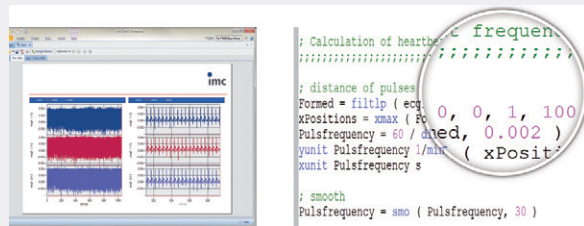

Find instead of search

With the imc SEARCH database solution, you store and manage all your measurement and test data in a central database. Data can be globally searched, filtered, sorted and automatically evaluated together with the analysis software imc FAMOS.

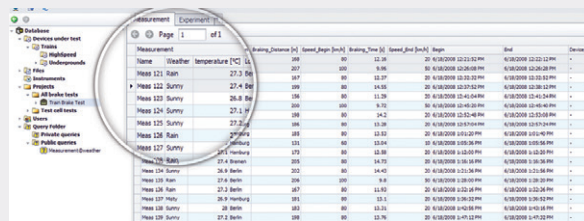

Cloud-Services

The imc WEBDEVICES cloud platform allows remote, unmanned and fully automatic monitoring of vehicles, machines, plants and buildings, recording status data and carrying out remote tests over long distances.

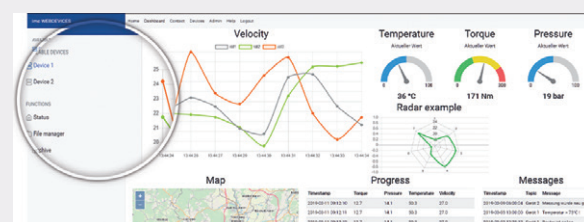

Technical Data

Base unit

| CRXT-2000 | |
|--|--------------|
| General | |
| System sampling rate | 2000 kSps |
| Operating conditions | |
| Temperature range | -40 .. +85°C |
| Condensation-proof | ● |
| Shock and vibration | MIL 810F |
| Connectivity | |
| Ethernet | 1 GBit |
| Internal Wi-Fi adapter IEEE 802.11.n (300 Mbit/s) | ○ |
| EtherCAT connection for distributed CRXT modules | ○ |
| GPS connector | ● |
| imc handheld display | ● |
| Remote control main switch | ● |
| Programmable LEDs for status indication | ● |
| Isolated synchronization signal | ● |
| Data storage | |
| CFast card slot | ○ |
| Storage on PC / network drive (NAS) | ● |
| SSD hard drive (internal) | ○ |
| Autonomous device capabilities | |
| Complex trigger functionality PC-independent | ● |
| Onboard real-time data analysis (imc Online FAMOS) | ● |
| Autarkic operation without PC, self-start (timer, absolute time) | ● |
| Synchronization & clock | |
| Master-Slave between imc systems | ● |
| NTP and PTP network-based synchronization | ● |
| Via external GPS signal | ● |
| Via external IRIG-B & DCF-77 signal | ● |
| Fieldbus options | |
| CAN, CAN-FD | ○ |
| LIN | ○ |
| FlexRay | ○ |
| MVB | ○ |
| ARINC | ○ |
| XCPoE (Master or Slave) | ○ |
| EtherCAT Slave | ○ |
| Power supply | |
| DC input 10V to 50V (isolated) | ● |
| AC/DC adapter (110 to 230VAC) | ● |
| Supply of external modules via Power-over-EtherCAT | ○ |
| Data integrity in case of power failure | ● |
| Long-term UPS (NiMH) | ○ |



Key: ● standard, ○ optional

Analog amplifier modules

| module name CRXT/xxx | size | | connector | | speed | | voltage mode | | | current | temp | ICP, supply | | bridge mode | | | | | | | | | | |
|--|----------|-------|--------------------|------|-------------------------------------|----------------------------|-----------------------|----------------------------|-------------------|----------------------|---------------------|-----------------|--------------|-------------|---------------------|----------|--------------------------------|-------------|-------------|----------------|---------------|-----------------------|--------------|--------------|
| | channels | slots | standard connector | TEDS | max. sampling rate (per channel) | signal bandwidth (-3dB) | isolated voltage mode | min. voltage range (mV) | voltage up to 10V | voltage up to 50/60V | 20mA internal shunt | 20mA shunt plug | thermocouple | PT100 | ICP mode integrated | ICP plug | sensor supply (per channel) | full bridge | half bridge | quarter bridge | DC excitation | AC excitation (5 kHz) | single SENSE | double SENSE |
| Voltage measurement | | | | | | | | | | | | | | | | | | | | | | | | |
| LV3-8 | 8 | 1 | DSUB-15 | ● | 100 kHz | 48 kHz | | 5 | ● | ● | ● | | | | ○ | ○ | | | | | | | | |
| Voltage and temperature | | | | | | | | | | | | | | | | | | | | | | | | |
| ISO2-8 | 8 | 1 | DSUB-15 | ● | 100 kHz | 11 kHz | ● | 50 | ● | ● | ● | ● | ● | | ○ | ○ | | | | | | | | |
| ISO2-8-L | 8 | 2 | LEMO.1B | ● | 100 kHz | 11 kHz | ● | 50 | ● | ● | ● | ● | ● | | ○ | ○ | | | | | | | | |
| ISO2-16-2T | 16 | 2 | Thermo | | 100 kHz | 2 kHz | ● | | | | | ● | ● | | | | | | | | | | | |
| ISOF-8 | 8 | 1 | DSUB-15 | ● | 100 kHz | 48 kHz | ● | 50 | ● | ● | ● | ● | ● | | ○ | ○ | | | | | | | | |
| ISOF-8-L | 8 | 2 | LEMO.1B | ● | 100 kHz | 48 kHz | ● | 50 | ● | ● | ● | ● | ● | | ○ | ○ | | | | | | | | |
| Audio & vibration measurement | | | | | | | | | | | | | | | | | | | | | | | | |
| ICPU2-8 | 8 | 2 | BNC | ● | 100 kHz | 48 kHz | | 5 | ● | ● | | | | ● | | | | | | | | | | |
| AUDIO2-4 | 4 | 2 | BNC | ● | 100 kHz | 48 kHz | ● | 5 | ● | ● | | | | ● | | | | | | | | | | |
| AUDIO2-4 MIC | 4 | 2 | BNC, LEMO.1B | ● | 100 kHz | 48 kHz | ● | 5 | ● | ● | | | | ● | | ● | ● | | | | | | | |
| Bridge and strain gauge measurement | | | | | | | | | | | | | | | | | | | | | | | | |
| BR2-4 | 4 | 1 | DSUB-15 | ● | 100 kHz | 14 kHz | | 5 | ● | ● | ● | | | | ○ | ● | | ● | ● | ● | ● | ● | ● | ● |
| B-8 | 8 | 2 | DSUB-15 | ● | 100 kHz | 48 kHz | | 5 | ● | | ● | ● | | | ○ | ● | | ● | ● | ● | ● | ● | ● | ● |
| DCB2-8 | 8 | 2 | DSUB-15 | ● | 100 kHz | 5 kHz | | 5 | ● | | ● | ● | | | ○ | ● | | ● | ● | ● | ● | ● | ● | ● |
| For universal use | | | | | | | | | | | | | | | | | | | | | | | | |
| UNI2-8 | 8 | 2 | DSUB-15 | ● | 100 kHz | 48 kHz | | 5 | ● | ● | ● | ● | ● | ● | ○ | ● | | ● | ● | ● | ● | ● | ● | ● |
| UNI-4 | 4 | 1 | DSUB-15 | ● | 100 kHz | 48 kHz | ● | 2,5 | ● | ● | ● | ● | ● | ● | ○ | ● | | ● | ● | ● | ● | ● | ● | ● |

TEDS-support:

All imc CRONOS-XT amplifiers support TEDS (Transducer Electronic Data Sheet) for automatic sensor recognition and configuration (Plug & Measure functionality). Simply connect the sensor, access TEDS and the channel configuration is ready.

Digital inputs and outputs and counter/encoder inputs

| module name CRXT/xxx | size | connector | digital I/O DAC | | | | pulse counter | | |
|-------------------------|------|-----------|--------------------|---------------------|----------------|----------------|----------------------|-------------------|---------------------|
| | | | digital input Bits | digital output Bits | analog outputs | counter inputs | quadrature mode chan | counter frequency | analog sin/cos mode |
| Pulse counter | | | | | | | | | |
| HRENC-4 | 1 | DSUB-15 | | | | 4 | 4 | 256 MHz | ● |
| Digital I/O, DAC | | | | | | | | | |
| DI2-16 | 1 | DSUB-15 | 16 | | | | | | |
| DO-16-HC | 1 | DSUB-15 | | 16 | | | | | |
| DAC-8 | 1 | DSUB-15 | | | 8 | | | | |

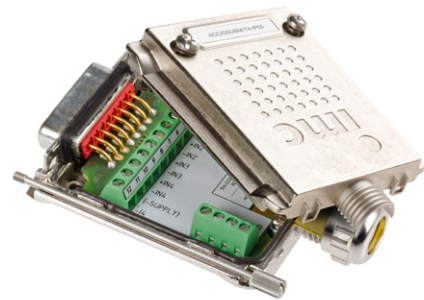

Waterproof DSUB connector plug for universal signal connection

Digital I/O: The digital inputs and outputs are galvanically isolated and configurable for 24V / 5V (TTL/COMOS) with a maximum output current of 0.7 A.

Counter: The counter inputs have full analog input conditioning with 500 kHz analog bandwidth (differential input), analog filter and software adjustable switching thresholds. The supported measurement modes are event counter, time, frequency, speed, rpm, angle and distance.

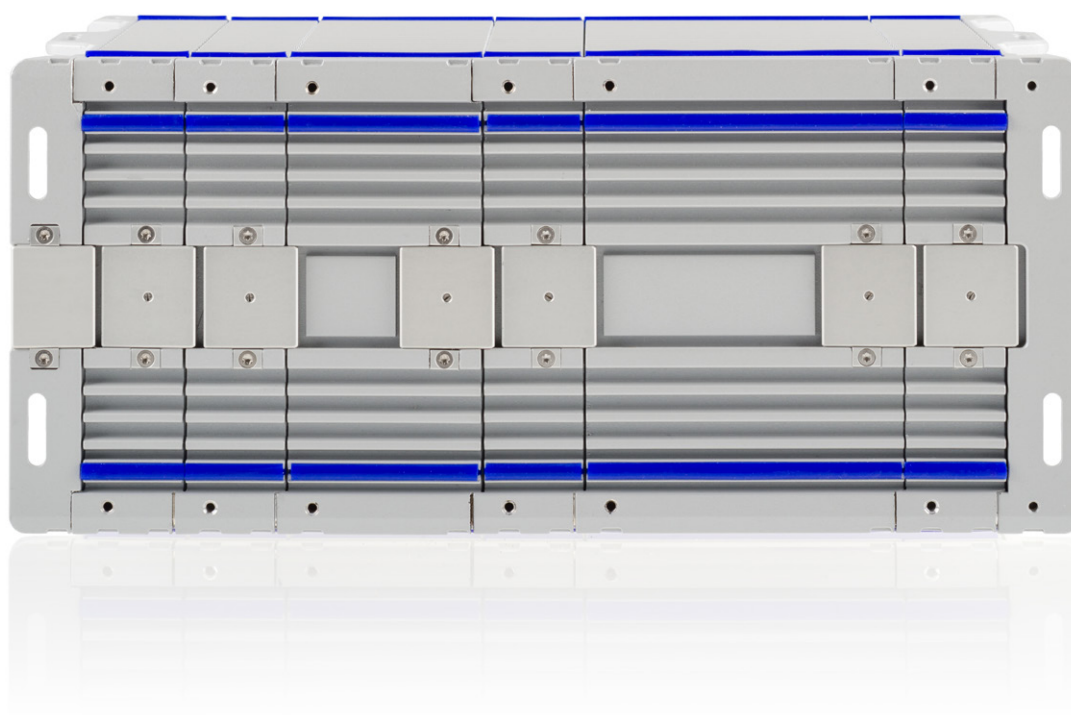

imc Test & Measurement GmbH

Voltastraße 5
D-13355 Berlin
Germany

Tel.: +49 (0)30 - 46 70 90 0
Fax: +49 (0)30 - 463 15 76
hotline@imc-tm.com
www.imc-tm.com